

User Guide
6614-2210

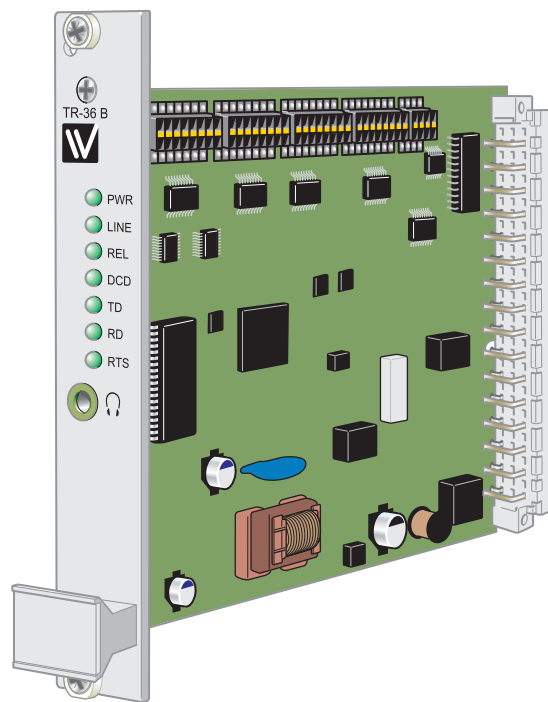

TR-36B



*Tele and leased line modem
for RV-07 19" rack system*

www.westermo.com

Legal information

The contents of this document are provided "as is". Except as required by applicable law, no warranties of any kind, either express or implied, including, but not limited to, the implied warranties of merchantability and fitness for a particular purpose, are made in relation to the accuracy and reliability or contents of this document. Westermo reserves the right to revise this document or withdraw it at any time without prior notice.

Under no circumstances shall Westermo be responsible for any loss of data or income or any special, incidental, and consequential or indirect damages howsoever caused.

More information about Westermo can be found at the following Internet address:

<http://www.westermo.com>

Safety



Before installation:

Read this manual completely and gather all information on the unit. Make sure that you understand it fully. Check that your application does not exceed the safe operating specifications for this unit.

This unit should only be installed by qualified personnel.

This unit should be built-in to an apparatus cabinet, or similar, where access is restricted to service personnel only.

The power supply wiring must be sufficiently fused, and if necessary it must be possible to disconnect manually from the power supply. Ensure compliance to national installation regulations.

This unit uses convection cooling. To avoid obstructing the airflow around the unit, follow the spacing recommendations (see Cooling section).

Before mounting, using or removing this unit:



Prevent access to hazardous voltage by disconnecting the unit from power supply and all other electrical connections.

Warning! Do not open connected unit. Hazardous voltage may occur within this unit when connected to power supply or TNV circuits.

Care recommendations

Follow the care recommendations below to maintain full operation of unit and to fulfil the warranty obligations.

This unit must not be operating with removed covers or lids.

Do not attempt to disassemble the unit. There are no user serviceable parts inside.

Do not drop, knock or shake the unit, rough handling above the specification may cause damage to internal circuit boards.

Do not use harsh chemicals, cleaning solvents or strong detergents to clean the unit.

Do not paint the unit. Paint can clog the unit and prevent proper operation.

Do not expose the unit to any kind of liquids (rain, beverages, etc). The unit is not waterproof. Keep the unit within the specified humidity levels.

Do not use or store the unit in dusty, dirty areas, connectors as well as other mechanical part may be damaged.

If the unit is not working properly, contact the place of purchase, nearest Westermo distributor office or Westermo Tech support.

Maintenance

No maintenance is required, as long as the unit is used as intended within the specified conditions.

Agency approvals and standards compliance, TR-36B

Type	Approved Agency/ W-mo	Approval / Compliance
EMC	W-mo	EN 61000-6-2, Immunity industrial environments
	W-mo	EN 55024, Immunity IT equipment
	W-mo	EN 61000-6-4, Emission industrial environments
	W-mo	FCC part 15 Class A
	W-mo	EN 50121-4, Railway signalling and telecommunications apparatus
	W-mo	IEC 62236-4, Railway signalling and telecommunications apparatus
Safety	W-mo	EN 60950-1, IT equipment
PSTN		ETSI TS103 021-1, ETSI TS103 021-2, ETSI TS103 021-3

FCC Part 15.105 Notice:

This equipment has been tested and found to comply with the limits for a Class A digital device, pursuant to Part 15 of the FCC Rules. These limits are designed to provide reasonable protection against harmful interference in a industrial installation. This equipment generates, uses and can radiate radio frequency energy and, if not installed and used in accordance with the instructions, may cause harmful interference to radio communications. However, there is no guarantee that interference will not occur in a particular installation. If this equipment does cause harmful interference to radio or television reception, which can be determined by turning the equipment off and on, the user is encouraged to try to correct the interference by one or more of the following measures:

- ⌘ Reorient or relocate the receiving antenna
- ⌘ Increase the separation between the equipment and receiver
- ⌘ Connect the equipment into an outlet on a circuit different from that to which the receiver is connected
- ⌘ Consult the dealer or an experienced radio/TV technician for help.

Declaration of Conformity



Westermo Teleindustri AB

Declaration of conformity

The manufacturer Westermo Teleindustri AB
SE-640 40 Stora Sundby, Sweden

Herewith declares that the product(s)

Type of product	Model	Art no
Rack mounted Tele and Leased Line modem	TR-36B	3614-0510

is in conformity with the following EC directive(s).

No	Short name
2004/108/EC	Electromagnetic Compatibility (EMC)
1999/5/EC	Radio and telecommunications terminal equipment (R&TTE)

References of standards applied for this EC declaration of conformity.

No	Title	Issue
EN 61000-6-2	Immunity for industrial environments	2005
EN 61000-6-4	Emission standard for industrial environments.	2007
EN 50121-4	Railway applications – Electromagnetic compatibility – Emission and Immunity of the signalling and telecommunications apparatus	2006
IEC 62236-4	Railway signalling and telecommunications apparatus	2003
EN 55024	Information technology equipment – Immunity	1998 + A1:2001 + A2:2003

The last two digits of the year in which the CE marking was affixed: 08

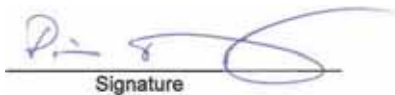

Signature

Pierre Öberg
R&D Manager
14th October 2008

Postadress/Postal address	Tel.	Telefax	Postgiro	Bankgiro	Org.nr/ Corp. identity number	Registered office
S-640 40 Stora Sundby Sweden	016-428000 Int+46 16428000	016-428001 Int+46 16428001	52 72 79-4	5671-5550	556361-2604	Eskilstuna

Type tests and environmental conditions, TR-36B

Electromagnetic Compatibility			
Phenomena	Test	Description	Test levels
ESD	EN 61000-4-2	Enclosure contact	± 6 kV
		Enclosure air	± 8 kV
RF field AM modulated	IEC 61000-4-3	Enclosure	20 V/m 80% AM (1 kHz), 80 – 2 700 MHz
Fast transient	EN 61000-4-4	Signal ports	± 2 kV
		Power ports	± 2 kV
Surge	EN 61000-4-5	Signal ports unbalanced	± 2 kV line to earth, ± 2 kV line to line
		Signal ports balanced	± 2 kV line to earth, ± 1 kV line to line
		Power ports	± 2 kV line to earth, ± 2 kV line to line
RF conducted	EN 61000-4-6	Signal ports	10 V 80% AM (1 kHz), 0.15 – 80 MHz
		Power ports	10 V 80% AM (1 kHz), 0.15 – 80 MHz
Voltage dips and interruption	EN 61000-4-11	AC power ports	10 & 5 000 ms, interruption 10 & 500 ms, 30% reduction 100 & 1 000 ms, 60% reduction
Mains freq. 50 Hz	EN 61000-4-16	Signal ports	100 V 50 Hz line to earth
Mains freq. 50 Hz	SS 436 15 03	Signal ports	250 V 50 Hz line to line
Voltage dips and interruption	EN 61000-4-29	DC power ports	10 & 100 ms, interruption 10 ms, 30% reduction 10 ms, 60% reduction +20% above & -20% below rated voltage
Radiated emission	EN 55022	Enclosure	Class A
	FCC part 15		Class A
Conducted emission	EN 55022	AC power ports	Class B
	FCC part 15	AC power ports	Class B
	EN 55022	DC power ports	Class B
Dielectric strength	EN 60950	Signal port to other isolated ports	2 kVrms 50 Hz 1 min
		Power port to other isolated ports	3 kVrms 50 Hz 1 min 2 kVrms 50 Hz 1 min (@ rated power <60 V)
Environmental			
Temperature		Operating	-40 to +70°C
		Storage & Transport	-40 to +70°C
Humidity		Operating	5 to 95% relative humidity.
		Storage & Transport	5 to 95% relative humidity.
Altitude		Operating	2 000 m / 70 kPa
Reliability prediction (MTBF)	MIL C217F2	Operating	676000 h @ 25°C
Service life		Operating	10 year
Packaging			
Dimension W x H x D			20 x 100 x 175 mm
Weight			0.14 kg
Degree of protection	IEC 529	Enclosure	IP 20
Cooling			Convection
Mounting			RV07B 19" rack

Description

The TR-36B is a rack mount analogue V.34 PSTN and 2- or 4-wire leased line modem. It supports data rates of up to 115.2 kbit/s on the terminal side and modem modulation speeds of up to 33.6 kbit/s on the line side. The modem is designed to harsh industrial standards for applications where a number of modems are required in the same location. The unit has passed extensive approvals testing by both Westermo and external test houses, showing the modem can operate in environments with a high level of electromagnetic interference.

The TR-36B features a number of security functions such as password protection, dial-back security and caller ID answering making the modem ideal for critical industrial applications. The TR-36B can also be remotely configured making it ideal for use in unmanned installations.

The modem is designed to be prepared for unexpected faults. The modem is equipped with transient protection on the line side and a watchdog function that monitors and automatically resets the modem in the event of a fault. In case of a leased line failure, a PSTN dial backup facility can be configured for additional reliability.

The TR-36 is configurable via its serial interface using standard terminal emulation software using Hayes AT commands or the Westermo TD-Tool modem configuration utility. Additionally many functions of the TR-36B can be configured via the onboard DIP-switches.

The modem is designed for use in the Westermo RV-07B 19" rack, which can hold up to 16 cards as well as two PS-20 power supplies. The modems slide into the chassis from the front with all line connections terminating onto the backplane. The rack can hold up to 16 TR-36B modems and can also be externally powered by a 24V supply.

- ⌘ Data rate up to 33.6 kbit/s with Fast Connect
- ⌘ Terminal rate up to 115.2 kbit/s
- ⌘ 2- and 4-wire leased line
- ⌘ V.23 HDX with multidrop
- ⌘ DTR and incoming data dialling
- ⌘ DIP-switch configuration
- ⌘ Watchdog
- ⌘ Secure call back and access
- ⌘ Industrial environment transient protection on all interfaces
- ⌘ Up to 11 bits
- ⌘ Tri-Galvanic isolation (interface/line/supply)
- ⌘ Caller ID presentation and answering
- ⌘ Remote configuration
- ⌘ RS-422 / RS-485 interface
- ⌘ Dial backup for PSTN and Leased Line

Interface specifications

Power	
Rated voltage	12 to 48 VDC
Operating voltage	10 to 60 VDC
Rated current	130 mA @ 12 VDC 63 mA @ 24 VDC 40 mA @ 48 VDC
Rated frequency	DC
Power consumption	2W
Inrush current I^2t	6 mA ² S
Startup current	0.22 A _{peak}
Polarity	Polarity dependent
Connection	32-pin Europe connector

LED indicators

LED	Status	Indication of
RTS	OFF	RTS signal is inactive
	ON	RTS signal is active
RD	OFF	No data
	FLASH	The modem transmitting data on the DTE interface
TD	OFF	No data
	FLASH	The modem receiving data on the DTE interface
DCD	OFF	DCD signal is inactive
	ON	DCD signal is active, modem has detected a carrier or the signal is set to always on
REL	OFF	Reliable mode is off, direct or normal mode
	ON	Reliable mode is on
	FLASH	Reliable mode with error correction and compression
LINE	OFF	The modem is on-hook
	ON	The modem is off-hook with a established connection
	FLASH	Line backup interface in use
PWR	OFF	The modem has no power
	ON	The modem is up and running
	FLASH	The modem is in the power-on selftest

Connections

TR-36B

TR-36B have 1 Europe connector angled 32-pin male.

The connector has Westermo specific pin-out and is intended to be insert into RV-07B.

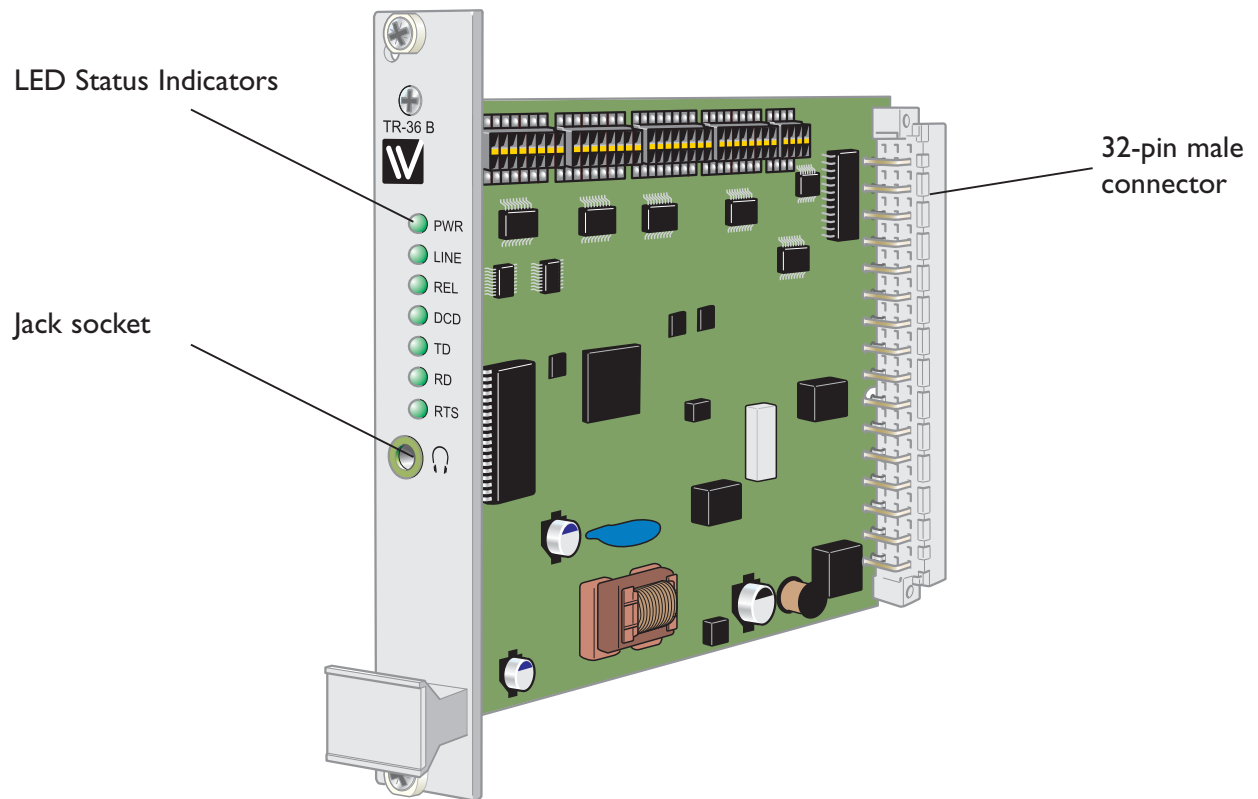

DIP-switch settings



Before DIP-switch settings:

Prevent damage to internal electronics from electrostatic discharges (ESD) by discharging your body to a grounding point (e.g. use of wrist strap).

NOTE DIP-switch alterations are only effective after a power on.

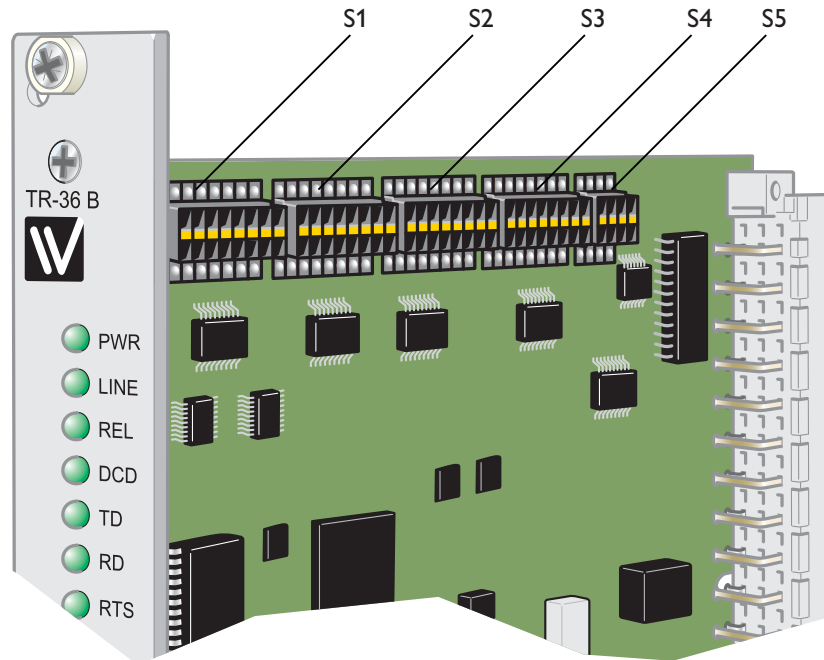

S1 DIP-switch Stored values / Auto detect



Use stored values



Auto detect*

* 300 and 600 bit/s not supported

S1 DIP-switch Selection of DTE speed



300 bit/s



9600 bit/s



600 bit/s



19.2 kbit/s



1200 bit/s



38.4 kbit/s



2400 bit/s



57.6 kbit/s

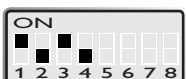

4800 bit/s



115.2 kbit/s

S1 DIP-switch

Selection of DTE format

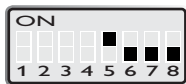

7E 1S



7N 2S



7O 1S

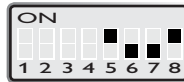

7E 2S



8N 1S

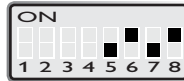

7O 2S



8E 1S

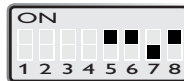

8N 2S

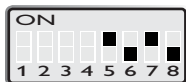

8O 1S



8E 2S



Direct mode 8E1 or 8O1
8O1 in command mode

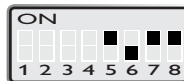

8O 2S



Direct mode 7E1 or 7O1
8N1 in command mode

S2 DIP-switch

Leased Line Mode selection

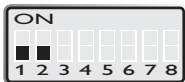

Leased line disable,
PSTN enable

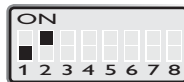

Leased line answering



Leased line V.23 multidrop
For V.23 Multidrop settings,
see selection below.

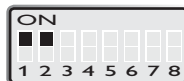

Leased line calling

S2 DIP-switch

DTE interface Selection



RS-422/485 disable,
RS-232 enable

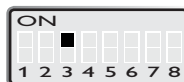

RS-422/485 enable,
RS-232 disable

**S2 DIP-switch
RS-422/485**



RS-422/485, 2-wire

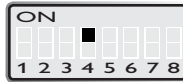

RS-422/485, 4-wire

**S2 DIP-switch
Leased line 2/4 wire selection**



Leased line 2-wire



Leased line 4-wire

**S2 DIP-switch
Selection PSTN backup of Leased line**



Backup of leased line disabled

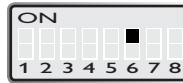

Backup of leased line enabled

**S2 DIP-switch
Selection of answering/calling mode for PSTN backed up Leased Line**



Answering

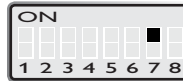

Calling

**S2 DIP-switch
Remote configuration control**



Use stored values

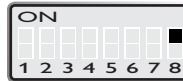

Remote configuration disabled
(AT*WRCA=0)

S3 DIP-switch

Selection of line speed and modulation

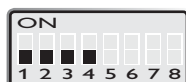

Use saved parameters defined by AT+MS



Auto V.32bis V32/V34

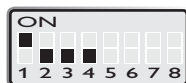

V.21 300

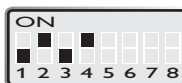

V.32bis 14400

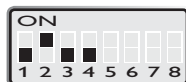

V.23 1200 hdx

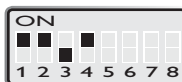

V.34 19200



V.22 1200

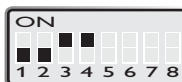

V.34 24000



V.22bis 2400

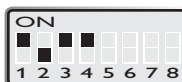

V.34 28 800

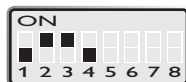

V.32bis 4800

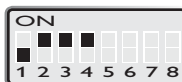

V.34 33600

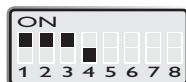

Auto V.32/V32bis

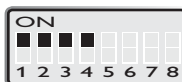

Automatic line speed

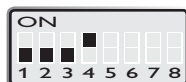

V.32bis 9600

S3 DIP-switch

PLC parameter setting



Use stored values

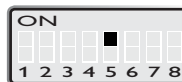

PLC settings (ATQ1E0&C1&K0&A1)

S3 DIP-switch

Flow control DTE interface



Use stored value for AT&K_n

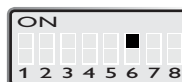

RTS/CTS flow control enable (AT&K₃)

S3 DIP-switch

Dial abort



Use stored values

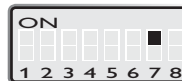

Dial abort disabled (AT&A₁)

S3 DIP-switch

Blind dialing



Use stored values



Enable blind dialing (ATX₃)

S4 DIP-switch
Set modem to factory default



Use stored values

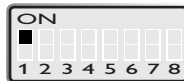

Restore factory default setting*

Don't leave S4:1 in ON position if not intended to restore factory setting at every power on.

S4 DIP-switch
DCD, DTR and DSR control



Use stored values



DCD and DSR always on,
DTR ignored (AT&C0&D0&S0)

S4 DIP-switch
Data compression control



Use stored values



Data compression disabled
(AT%C0)

S4 DIP-switch
Auto retrain control



Use stored values



Auto retrain disabled (AT%E0)

S4 DIP-switch
Line mode setting



Use stored values



Reliable mode enable (AT\N2)



Buffer mode enabled (AT\N0)



Direct Mode enabled (AT\N1)

S5 DIP-switch RS-422/485 termination



No termination



Termination of R in 4-wire connection

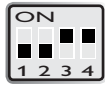

Termination of both T and R in 2-wire connection

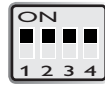

Termination of both T and R in 4-wire connection

Factory settings



S1



S3



S5



S2

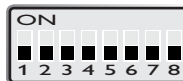

S4

V.23 2- / 4-wire HDX- / FDX-leased line settings

S1 DIP-switch

Selection of DTE speed



S1 DIP-switch

Selection of DTE-format

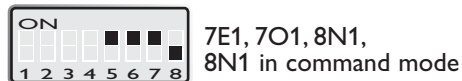
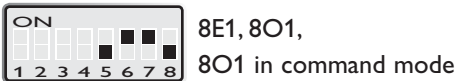

S2 DIP-switch

Leased line mode selection

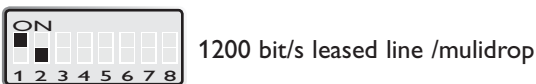

S2 DIP-switch

Leased line 2/4-wire selection



S3 DIP-switch

V.23 line modulation



S3 DIP-switch

Carrier active using RTS or incoming data



S4 DIP-switch









Permanent carrier control



Termination recommendations of Leased lines and Dial-up connections

In some connections the communication line (Leased Line or PSTN) must be terminated. The table below shows the right way to activate the termination for different usages. As a standard, the receiver in multidrop systems at the end points shall be terminated.

S4 DIP-switch
Termination recommendations for TR-36B

 <p>PSTN</p>	 <p>Multidrop V23 2-wire – endunit</p>
 <p>PSTN Backup</p>	 <p>Multidrop V23 2-wire – dropunit</p>
 <p>2-wire Leased Line</p>	 <p>Multidrop V23 4-wire – endunit</p>
 <p>4-wire Leased Line</p>	 <p>Multidrop V23 4-wire – dropunit</p>

RS-422/485 general advice

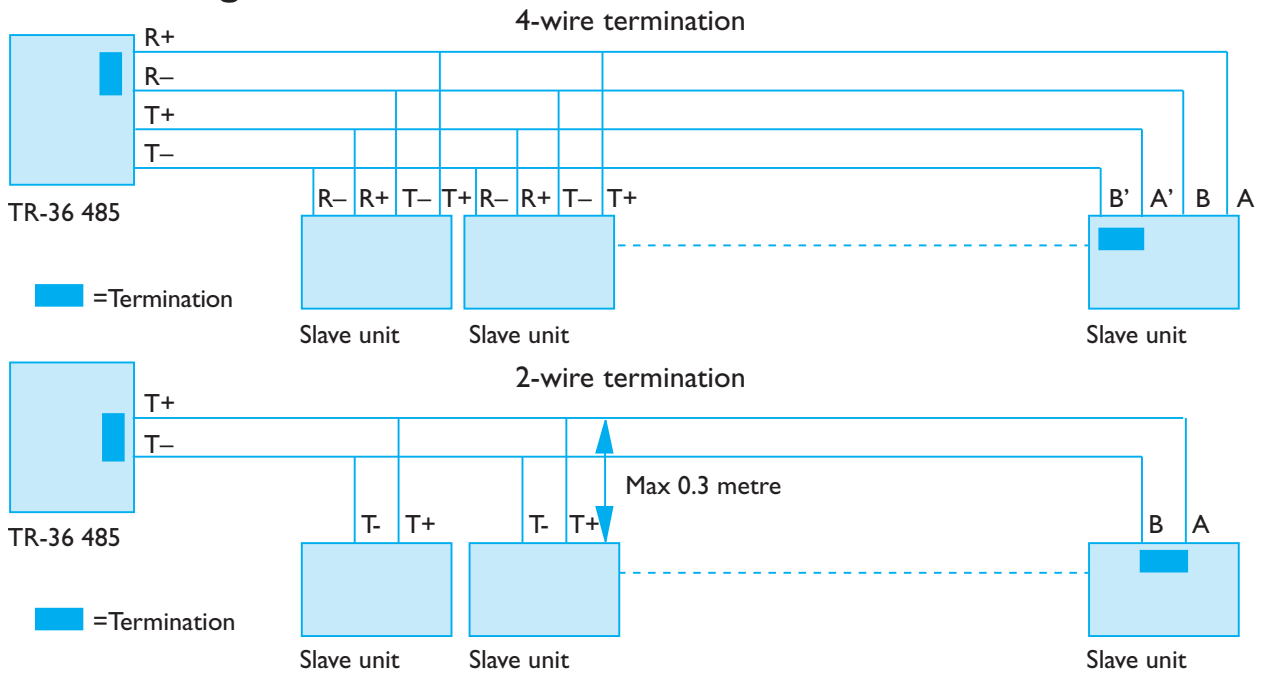

Termination recommendations

The RS-422/485 line must be terminated. In the TR-36B, the termination is combined with fail-safe functionality. The termination is used to prevent undefined states when the bus is in tri-state condition.

- ⌘ Using 2-wire RS-485 both ends should be terminated.
- ⌘ Using 4-wire RS-485 both pairs shall be terminated at both ends.
- ⌘ Using 4-wire RS-422 it's only necessary to terminate the receivers.

RS-422/485 connection pins can be differently named. For some equipment brands the T+ corresponds to A, but other brands might use some other naming convention. If a unit does not work it can help to swap A and B.

Mounting /Removal

Before mounting or removing the unit:

Make sure that the RV-07B modem rack has been installed according to instructions.

Mounting

The TR-36 is designed to fit into the RV-07B rack. The modem is installed by sliding the card along the slot guides.

Ensure the card is the correct way up, the handle will be at the

bottom of the card. Press firmly but carefully until full connection between the modems 32 pin male connector and the connector on the backplane is achieved.

To ensure proper galvanic connection between front panels, do not leave empty slots between modems. Always add modems from one side in the rack

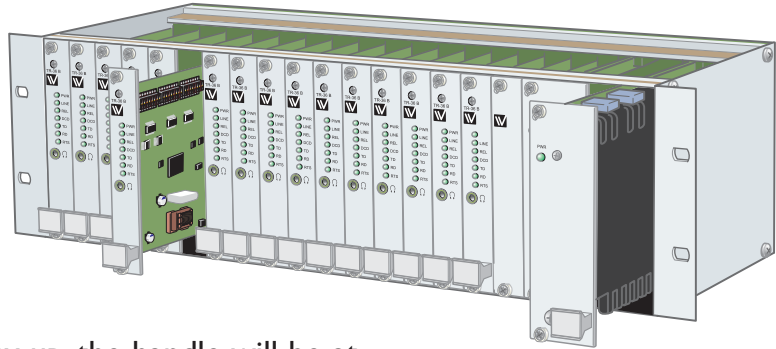



Westermo Teleindustri AB • SE-640 40 Stora Sundby, Sweden
Phone +46 16 42 80 00 Fax +46 16 42 80 01
E-mail: info@westermo.se
Westermo Web site: www.westermo.com

Subsidiaries

Westermo Data Communications AB
SE-724 81 Västerås
Phone: +46 (0)16 42 80 00 • Fax: +46 (0)21 35 18 50
info.sverige@westermo.se

Westermo Data Communications Ltd
Talisman Business Centre • Duncan Road
Park Gate, Southampton • SO31 7GA
Phone: +44(0)1489 580-585 • Fax: +44(0)1489 580586
E-Mail: sales@westermo.co.uk

Westermo Data Communications GmbH
Goethestraße 67, 68753 Waghäusel
Tel.: +49(0)7254-95400-0 • Fax: +49(0)7254-95400-9
E-Mail: info@westermo.de

Westermo Data Communications S.A.R.L.
9 Chemin de Chilly 91160 CHAMPLAN
Tél : +33 1 69 10 21 00 • Fax : +33 1 69 10 21 01
E-mail : infos@westermo.fr

Westermo Data Communications Pte Ltd
2 Soon Wing Road #08-05
Soon Wing Industrial Building
Singapore 347893
Phone +65 6743 9801 • Fax +65 6745 0670
E-mail: earnestphua@westermo.com.sg

Westermo Teleindustri AB have distributors in several countries, contact us for further information.